

Fixing Quantities

Length of Nominal Dome Side (mm)	Number of fixings per side
600, 750	2
900, 1050, 1200	3
1350, 1500, 1650	4
1800, 1950	5
2100, 2250	6
2400	7

(All fixings supplied in packs of 5.)

Mardome Contents

i Please unpack and check that all correct parts are included and undamaged.

All Mardome Trade

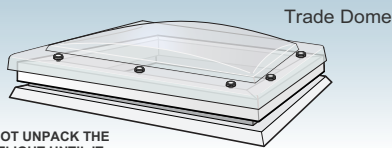

All Mardome Ultra

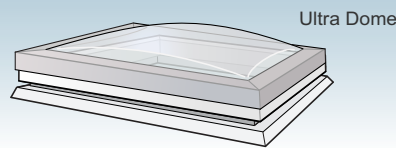

OR

⚠ DO NOT UNPACK THE ROOFLIGHT UNTIL IT IS READY TO BE INSTALLED

With either assembly, you will receive:
Kerb Fixings

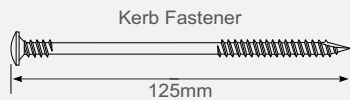

With either assembly, you will receive:
Mardome Opening Unit Extras

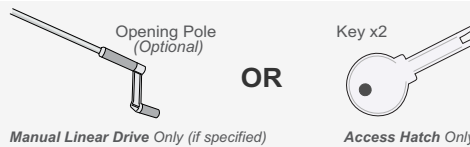

Mardome Opening Unit - Pre-Installation Information

i Please select the relevant detail below for your product:

Installation Instructions

Manual Opening dome on to existing upstand

i N.B. Kerb must be installed with hinges facing up-slope.

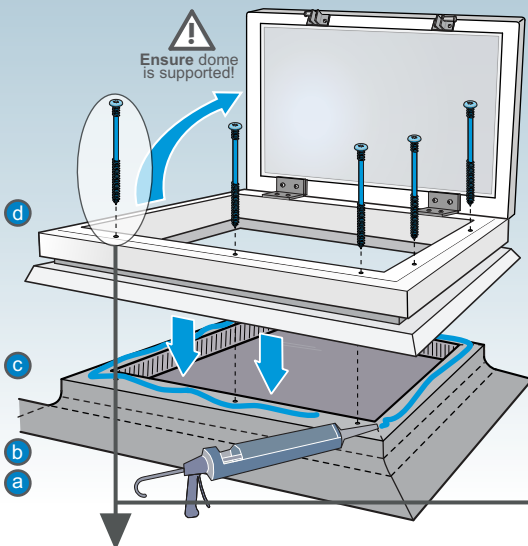

Access Hatch on to existing upstand

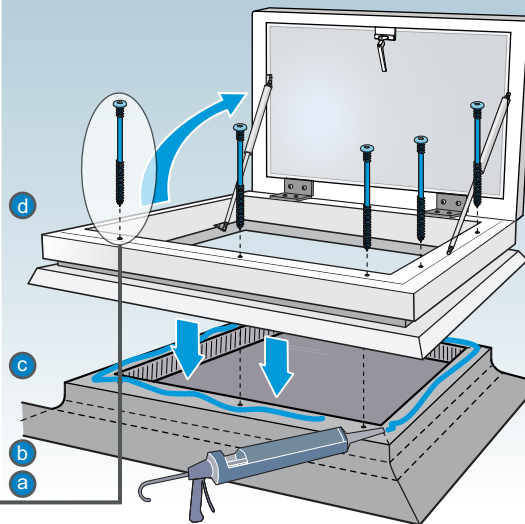

⚠ Ensure dome is supported in open position to avoid damage!

a Install roof covering to cover existing upstand in accordance with manufacturer's installation recommendations.

i N.B. It is important that there should be no excessive build up of layers, the top surface should be level and free from any protrusions or projections which may prevent adequate weather proofing.

b Carefully remove roof light from its packaging and ensure that hinged frame is unlocked and can be opened to 90°.

c Mastic/Silicone around the edge of the upstand opening and correctly place kerb, ensuring it is located squarely to the upstand with hinges facing up-slope.

d Fix kerb to the builders upstand using the 125mm kerb fastener.

e Ensure that the hinged dome is connected to the frame and locked into the closed position

Kerb Fixing

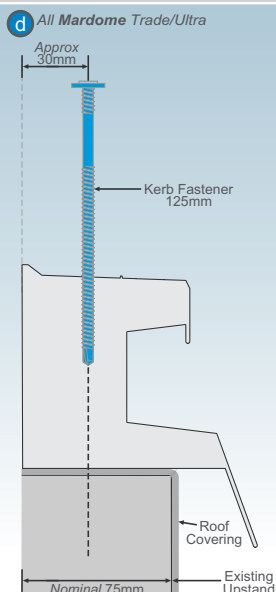

Mardome Installation

⚠ Please note that all Health and Safety Regulations must be followed on site throughout the installation process.

b e For Manual Linear Drive Connection

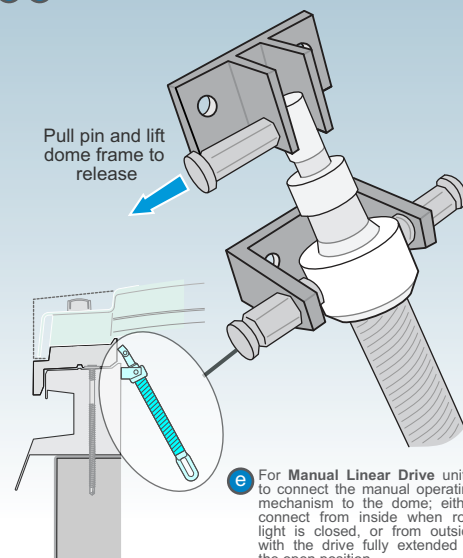

e For Access Hatch locking/unlocking

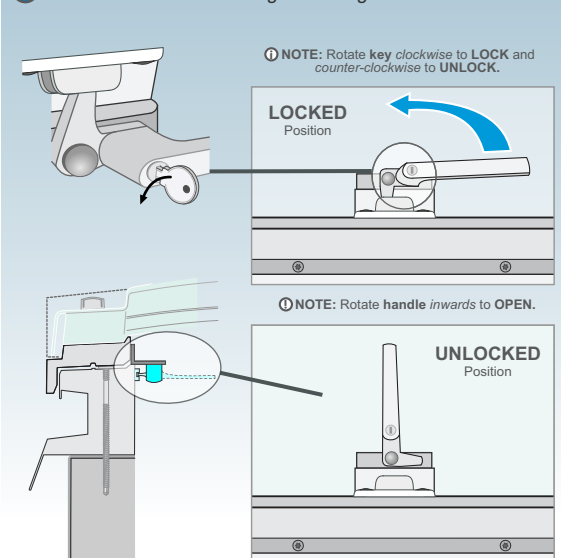

Mardome Contents

Please unpack and check that all correct parts are included and undamaged.

All Mardome Trade

Trade Dome



All Mardome Ultra

Ultra Dome

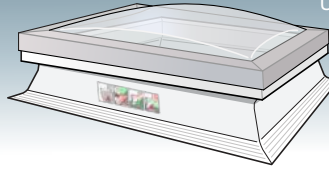

OR

DO NOT UNPACK THE ROOFLIGHT UNTIL IT IS READY TO BE INSTALLED

With either assembly, you will receive:

Kerb Fixings

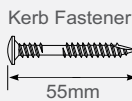

With either assembly, you will receive:

Mardome Opening Unit Extras

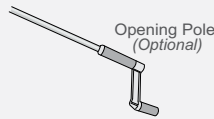

OR



Manual Linear Drive Only (if specified)

Access Hatch Only

Fixing Quantities

Length of Nominal Dome Side (mm)	Number of fixings per side
600, 750	2
900, 1050, 1200	3
1350, 1500, 1650	4
1800, 1950	5
2100, 2250	6
2400	7

(All fixings supplied in packs of 5.)

Mardome Installation

Please note that all Health and Safety Regulations must be followed on site throughout the installation process.

Manual Opening dome on to sloping or 300mm kerb

N.B. Kerb must be installed with hinges facing up-slope.

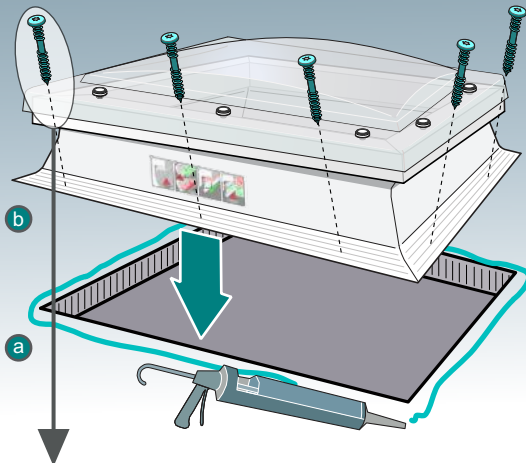

c Roof Covering Installation

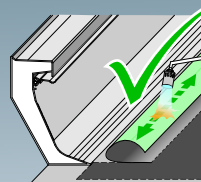

If required, lightly torch roof covering.



WARNING:
Never apply direct heat or naked flame to the roof light!

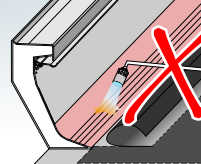

d **IMPORTANT:**
Roof Covering Clamp Locking



Push along line as shown to lock. **DO NOT** push on soft area!

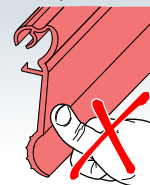

Installation Instructions

- Mastic/Silicone around the edge of the roof opening and correctly position dome, ensuring it is located squarely over the roof opening with hinges facing up-slope.
- Fix dome to the roof using the 55mm kerb fastener.

See above **Fixing Quantities** table for the correct quantity of fastenings required for the size of the dome.

N.B. Length of side refers to the nominal dome size (equivalent to inside base of kerb foot).
- Install roof covering up to lip, to stop under roof covering clamp, ensuring it **does not** foul clamp. Install in accordance with manufacturer's installation recommendations.
- Lock the roof covering clamp down fully, as shown.
- See e (below) for further information on opening mechanisms

Kerb Fixing

- b c** All Mardome Trade & Ultra
- Kerb
 - Roof Covering
 - Structural Member
 - Insulation

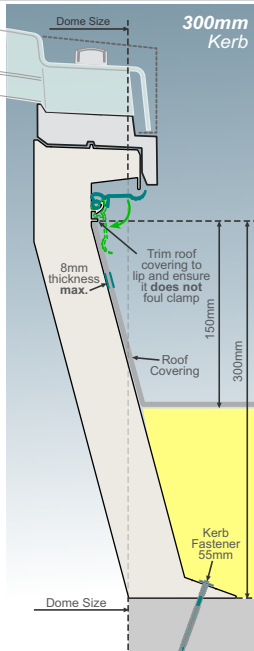
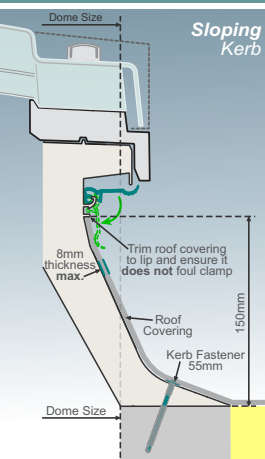

Mardome Opening Unit - Further Information

Please select the relevant detail below for your product:

e For Manual Linear Drive Connection

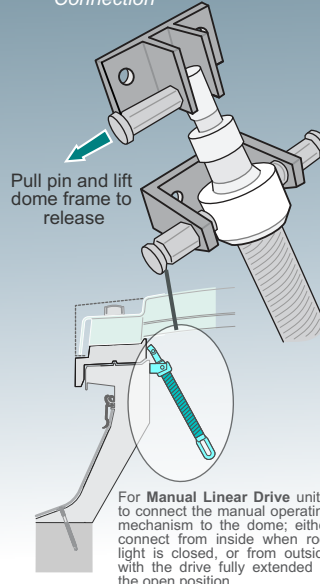

For Manual Linear Drive units, to connect the manual operating mechanism to the dome; either connect from inside when roof light is closed, or from outside with the drive fully extended in the open position.

e For Access Hatch locking/unlocking

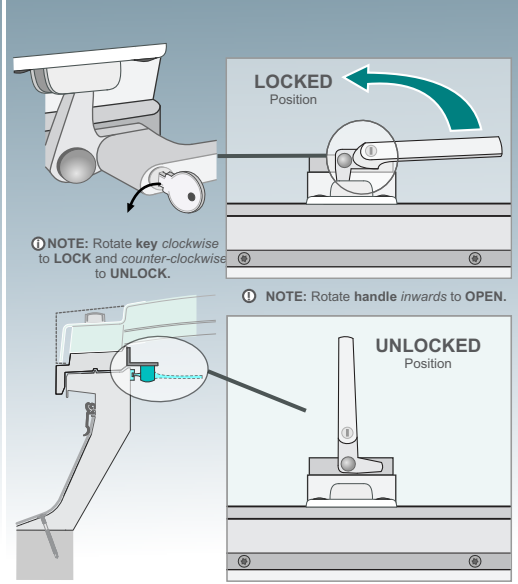

NOTE: Rotate key clockwise to LOCK and counter-clockwise to UNLOCK.

NOTE: Rotate handle inwards to OPEN.

TECHNICAL SUPPORT: For any technical information/queries please contact your supplier.